





YAMAHA MDX-M5

Minidisc Recorder

Lecteur Enregistreur De Minidisc

**OWNER'S MANUAL
MODE D'EMPLOI**

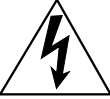
SAFETY INSTRUCTIONS

	CAUTION RISK OF ELECTRIC SHOCK DO NOT OPEN	
<p>CAUTION: TO REDUCE THE RISK OF ELECTRIC SHOCK, DO NOT REMOVE COVER (OR BACK). NO USER-SERVICEABLE PARTS INSIDE. REFER SERVICING TO QUALIFIED SERVICE PERSONNEL.</p>		

• Explanation of Graphical Symbols

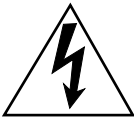

The lightning flash with arrowhead symbol, within an equilateral triangle, is intended to alert you to the presence of uninsulated "dangerous voltage" within the product's enclosure that may be of sufficient magnitude to constitute a risk of electric shock to persons.



The exclamation point within an equilateral triangle is intended to alert you to the presence of important operating and maintenance (servicing) instructions in the literature accompanying the appliance.

<p>WARNING TO REDUCE THE RISK OF FIRE OR ELECTRIC SHOCK, DO NOT EXPOSE THIS UNIT TO RAIN OR MOISTURE.</p>
--

<p>IMPORTANT! Please record the serial number of this unit in the space below.</p> <p>Model: Serial No.:</p> <p>The serial number is located on the rear of the unit. Retain this Owner's Manual in a safe place for future reference.</p>

- 1 Read Instructions – All the safety and operating instructions should be read before the unit is operated.
- 2 Retain Instructions – The safety and operating instructions should be retained for future reference.
- 3 Heed Warnings – All warnings on the unit and in the operating instructions should be adhered to.
- 4 Follow Instructions – All operating and other instructions should be followed.
- 5 Water and Moisture – The unit should not be used near water – for example, near a bathtub, washbowl, kitchen sink, laundry tub, in a wet basement, or near a swimming pool, etc.
- 6 Carts and Stands – The unit should be used only with a cart or stand that is recommended by the manufacturer.

6A A unit and cart combination should be moved with care. Quick stops, excessive force, and uneven surfaces may cause the unit and cart combination to overturn.



- 7 Wall or Ceiling Mounting – The unit should be mounted to a wall or ceiling only as recommended by the manufacturer.
- 8 Ventilation – The unit should be situated so that its location or position does not interfere with its proper ventilation. For example, the unit should not be situated on a bed, sofa, rug, or similar surface, that may block the ventilation openings; or placed in a built-in installation, such as a bookcase or cabinet that may impede the flow of air through the ventilation openings.
- 9 Heat – The unit should be situated away from heat sources such as radiators, stoves, or other appliances that produce heat.
- 10 Power Sources – The unit should be connected to a power supply only of the type described in the operating instructions or as marked on the unit.
- 11 Power-Cord Protection – Power-supply cords should be routed so that they are not likely to be walked on or pinched by items placed upon or against them, paying particular attention to cords at plugs, convenience receptacles, and the point where they exit from the unit.
- 12 Cleaning – The unit should be cleaned only as recommended by the manufacturer.
- 13 Nonuse Periods – The power cord of the unit should be unplugged from the outlet when left unused for a long period of time.
- 14 Object and Liquid Entry – Care should be taken so that objects do not fall into and liquids are not spilled into the inside of the unit.
- 15 Damage Requiring Service – The unit should be serviced by qualified service personnel when:
 - A. The power-supply cord or the plug has been damaged; or
 - B. Objects have fallen, or liquid has been spilled into the unit; or
 - C. The unit has been exposed to rain; or
 - D. The unit does not appear to operate normally or exhibits a marked change in performance; or
 - E. The unit has been dropped, or the cabinet damaged.
- 16 Servicing – The user should not attempt to service the unit beyond those means described in the operating instructions. All other servicing should be referred to qualified service personnel.
- 17 Power Lines – An outdoor antenna should be located away from power lines.
- 18 Grounding or Polarization – Precautions should be taken so that the grounding or polarization is not defeated.

FCC INFORMATION (for US customers only)

1. IMPORTANT NOTICE: DO NOT MODIFY THIS UNIT!

This product, when installed as indicated in the instructions contained in this manual, meets FCC requirements. Modifications not expressly approved by Yamaha may void your authority, granted by the FCC, to use the product.

2. IMPORTANT:

When connecting this product to accessories and/or another product use only high quality shielded cables. Cable/s supplied with this product MUST be used. Follow all installation instructions. Failure to follow instructions could void your FCC authorization to use this product in the USA.

3. NOTE:

This product has been tested and found to comply with the requirements listed in FCC Regulations, Part 15 for Class "B" digital devices. Compliance with these requirements provides a reasonable level of assurance that your use of this product in a residential environment will not result in harmful interference with other electronic devices.

This equipment generates/uses radio frequencies and, if not installed and used according to the instructions found in the users manual, may cause interference harmful to the operation of other electronic devices.

Compliance with FCC regulations does not guarantee that interference will not occur in all installations. If this product is found to be the source of interference, which can be determined by turning the unit "OFF" and "ON", please try to eliminate the problem by using one of the following measures:

Relocate either this product or the device that is being affected by the interference.

Utilize power outlets that are on different branch (circuit breaker or fuse) circuits or install AC line filter/s.

In the case of radio or TV interference, relocate/reorient the antenna. If the antenna lead-in is 300 ohm ribbon lead, change the lead-in to coaxial type cable.

If these corrective measures do not produce satisfactory results, please contact the local retailer authorized to distribute this type of product. If you can not locate the appropriate retailer, please contact Yamaha Electronics Corp., U.S.A. 6660 Orangethorpe Ave, Buena Park, CA 90620.

The above statements apply ONLY to those products distributed by Yamaha Corporation of America or its subsidiaries.

We Want You Listening For A Lifetime

YAMAHA and the Electronic Industries Association's Consumer Electronics Group want you to get the most out of your equipment by playing it at a safe level. One that lets the sound come through loud and clear without annoying blaring or distortion – and, most importantly, without affecting your sensitive hearing. Since hearing damage from loud sounds is often undetectable until it is too late, YAMAHA and the Electronic Industries Association's Consumer Electronics Group recommend you to avoid prolonged exposure from excessive volume levels.



For U.K. customers

If the socket outlets in the home are not suitable for the plug supplied with this appliance, it should be cut off and an appropriate 3 pin plug fitted. For details, refer to the instructions described below.

Note: The plug severed from the mains lead must be destroyed, as a plug with bared flexible cord is hazardous if engaged in a live socket outlet.

SPECIAL INSTRUCTIONS FOR U.K. MODEL

IMPORTANT:

The wire in the mains lead are coloured in accordance with the following code:

Blue: NEUTRAL
Brown: LIVE

As the colours of the wires in the mains lead of this apparatus may not correspond with the coloured markings identifying the terminals in your plug, proceed as follows: The wire which is coloured BLUE must be connected to the terminal which is marked with the letter N or coloured BLACK. The wire which is coloured BROWN must be connected to the terminal which is marked with the letter L or coloured RED. Making sure that neither core is connected to the earth terminal of the three pin plug.

SUPPLIED ACCESSORIES
ACCESSOIRES FOURNIS

- After unpacking, check that the following parts are contained.
- Après le déballage, vérifier que les pièces suivantes sont incluses.

- Remote control transmitter
- Télécommande

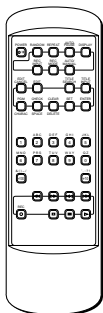

- Audio connecting cable
- Câbles de connexion audio

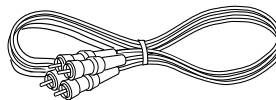

- System cable
- Câble système

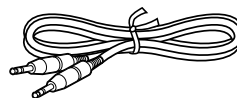

- Batteries (size AAA, UM/SEM-4, R7, HP-8)
- Piles (format AAA, UM/SEM-4, R7, HP-8)

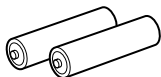

- Optical fiber cable
- Câble de fibres optiques



**FRONT PANEL
PANNEAU FRONTAL**

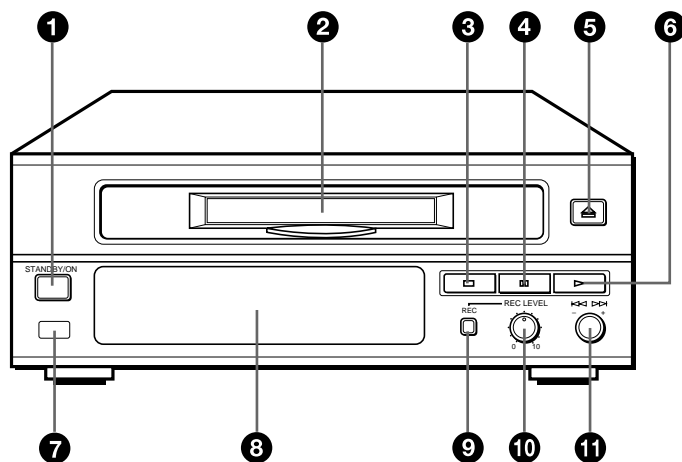

**REAR PANEL
PANNEAU ARRIERE**

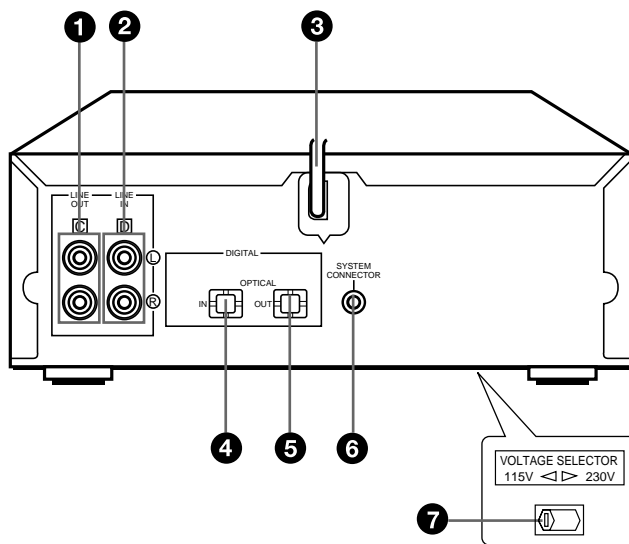

**DISPLAY
PANNEAU D'AFFICHAGE**

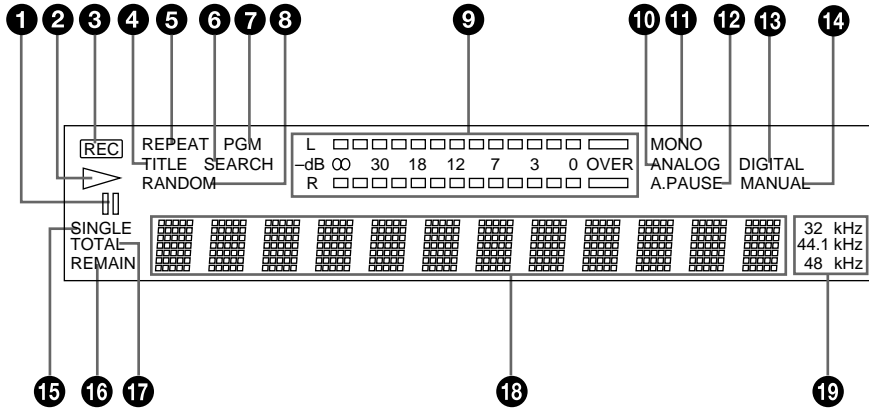

**REMOTE CONTROL TRANSMITTER
TELECOMMANDE**

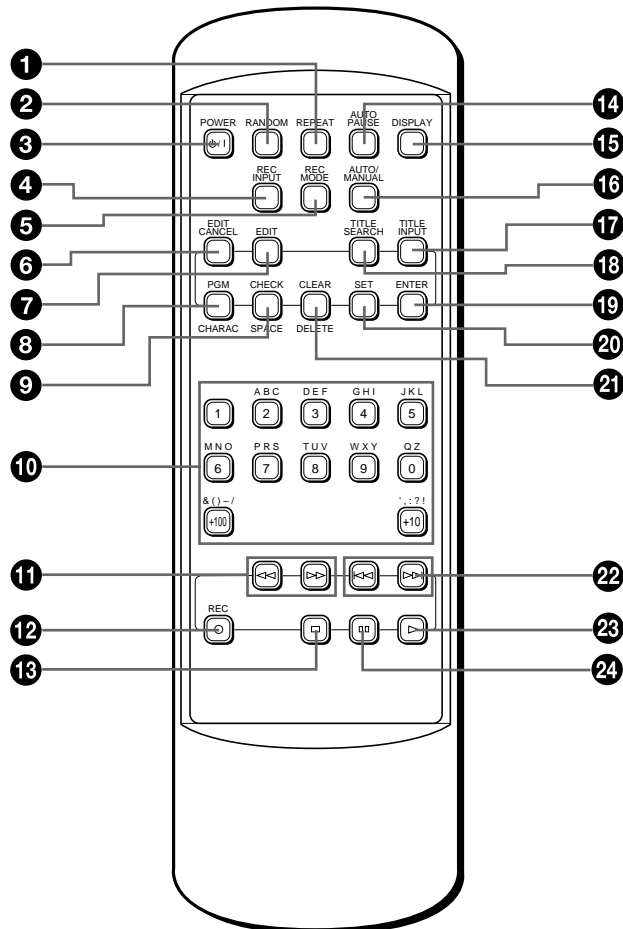

INTRODUCTION

Thank you for purchasing this YAMAHA product. We hope it will give you many years of trouble-free enjoyment. For the best performance, read this manual carefully. It will guide you in operating your YAMAHA product.

FEATURES

- **Random Access Programmable Play**
- **Random-Sequence Play**
- **Repeat Play**
- **An Automatic Sampling Rate Converter (32, 48kHz → 44.1kHz)**
- **Four Editing Features (Move, Erase, Divide, and Combine)**
- **Title Filing Capability**
- **Title Search Capability**
- **Monaural recording for long time recording**
- **Optical Digital Input/Output**
- **Full Operation Remote control**

When you connect the unit to CRX-M5

- **Automatic Synchronized Recording**
- **Timer Play**
- **Sleep Timer**
- **Recording Using Timer**

CONTENTS

PRECAUTIONS	2	EDITING	
NAMES OF BUTTONS, CONTROLS, AND INDICATORS	3	Before you start editing	17
GETTING STARTED		To undo an editing	17
Connecting the unit to the CRX-M5	4	Erase	18
Turning on/off the unit	5	Move	19
Preparing the remote control transmitter ..	6	Combine	21
PLAYBACK		Divide	22
MD playback	7	Titling	23
Selecting the time display	8	OTHER OPERATIONS	
Random-sequence play	9	Title search	25
Repeat play	10	Timer operation	25
Program play	10	ADDITIONAL INFORMATION	
Auto pause function	11	MD system limitations	26
RECORDING		About copy protection	27
Before recording	12	Notes about handling MDs	27
Recording on an MD	12	Troubleshooting	28
CD synchronized recording	14	Display messages	29
Monaural recording	15	Specifications	30
Changing recording mode	16		

PRECAUTIONS: READ THIS BEFORE OPERATING THE UNIT

CAUTIONS

- To assure the finest performance, please read this manual carefully. Keep it in a safe place for future reference.
- Install your unit in good ventilation, a cool, dry, clean place – away from windows, heat sources, vibration, dust, moisture, or cold. To avoid humming sounds, locate the unit away from other electrical appliances, motors, and transformers. To prevent fire or electrical shock, do not expose to rain and water.
- Do not operate the unit upside-down. It may overheat, possibly causing damage.
- Never open the cabinet. If something drops into the set, contact your dealer.
- Do not use force on switches, knobs or cords.
- When not planning to use this unit for long periods of time (i.e., vacation, etc.), disconnect the AC power plug from the wall outlet.
- Grounding or polarization – Precautions should be taken so that the grounding or polarization of the unit is not defeated.
- Do not clean the unit with chemical solvents; this might damage the finish. Use a clean, dry cloth.
- Be sure to read the “TROUBLESHOOTING” section on common operating errors before concluding that your unit is faulty.
- Do not place another component on top of this unit, as damage or discoloration on the surface of the unit may result.
- To prevent damage by lightning, disconnect the power cord from the wall outlet during an electrical storm.
- When disconnecting the power cord from the wall outlet, grasp the plug; do not pull the cord.
- Do not plug the AC power plug to the wall outlet before you finish all connections.
- The voltage to be used must be the same as that specified on this unit. Using this unit with a higher voltage than that which is specified is dangerous and may result in a fire or other type of accident causing damage. YAMAHA will not be held responsible for any damage resulting from use of this unit with a voltage other than that which is specified.
- Sudden temperature changes and storage or operation in an extremely humid environment may cause condensation inside the cabinet.

This unit is not disconnected from the AC power source as long as it is connected to the wall outlet, even if this unit itself is turned off. This state is called the standby mode. In this state, this unit is designed to consume a very small quantity of power.

CAUTION FOR CARRYING THE UNIT

Before carrying the unit, first remove a disc from the unit, press STANDBY/ON to turn the unit off, then disconnect the AC power plug from the wall outlet.

FOR CANADIAN CUSTOMERS

TO PREVENT ELECTRIC SHOCK, MATCH WIDE BLADE OF PLUG TO WIDE SLOT AND FULLY INSERT.

THIS CLASS B DIGITAL APPARATUS COMPLIES WITH CANADIAN ICES-003.

WARNING

To reduce the risk of fire or electric shock, do not expose this appliance to rain or moisture.

To avoid electrical shock, do not open the cabinet. Refer servicing to qualified personnel only.

DANGER

Invisible laser radiation when open and interlock failed or defeated.
Avoid direct exposure to beam.

CAUTION

Use of controls or adjustments or performance of procedures other than those specified herein may result in hazardous radiation exposure.

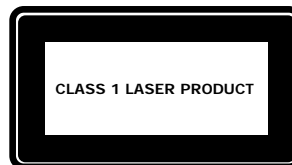

This compact disc player is classified as a CLASS 1 LASER product. The CLASS 1 LASER PRODUCT label is located on the rear exterior. (U.K., Europe, Singapore, and General models only.)

Laser component in this product is capable of emitting radiation exceeding the limit for Class 1.

NOTE

Please check the copyright laws in your country to record from records, compact discs, radio, etc. Recording of copyright material may infringe copyright laws.

FRONT PANEL (see the illustration on page 5)

- ❶ STANDBY/ON switch (5)
- ❷ Disc insert slot (7)
- ❸ ■ (stop) button (7)
- ❹ || (pause) button (7)
- ❺ △ (eject) button (7)
- ❻ ▶ (play) button (7)
- ❼ Remote control sensor (6)
- ❽ Display
- ❾ REC button (13)
- ❿ REC LEVEL control (13)
- ⓫ Jog dial/◀◀/▶▶ (skip)/+/- control (8, 23)

REAR PANEL (see the illustration on page 5)

- ❶ LINE OUT jacks (4)
- ❷ LINE IN jacks (4)
- ❸ AC power cord (4)
- ❹ DIGITAL OPTICAL IN jack (4)
- ❺ DIGITAL OPTICAL OUT jack (5)
- ❻ SYSTEM CONNECTOR jack (4)
- ❼ VOLTAGE SELECTOR switch (This selector on the bottom of the unit.) (2) (General model only)

DISPLAY (see the illustration on page 6)

- ❶ || (pause) indicator (7)
- ❷ ▷ (play) indicator (7)
- ❸ REC indicator (13)
- ❹ TITLE indicator (23)
- ❺ REPEAT indicator (10)
- ❻ SEARCH indicator (25)
- ❼ PGM (program) indicator (10)
- ❽ RANDOM indicator (9)
- ❾ Level indicator (13)
- ❿ ANALOG indicator (13)
- ⓫ MONO indicator (13)
- ⓬ A.PAUSE indicator (11)
- ⓭ DIGITAL indicator (13)
- ⓮ MANUAL indicator (14)
- ⓯ SINGLE indicator (8)
- ⓰ REMAIN indicator (9)
- ⓱ TOTAL indicator (9)
- ⓲ Multi information display
- ⓳ Sampling rate indicator

REMOTE CONTROL TRANSMITTER (see the illustration on page 6)

- ❶ REPEAT button (10)
- ❷ RANDOM button (9)
- ❸ POWER ⏻/⏿ button (5)
- ❹ REC INPUT button (13)
- ❺ REC MODE button (16)
- ❻ EDIT CANCEL button (17)
- ❼ EDIT button (18)
- ❽ PGM (program)/CHARAC (character) button (10, 24)
- ❾ CHECK/SPACE button (11, 24)
- ❿ Number/character buttons (8, 24)
- ⓫ ◀◀/▶▶ (search) buttons (8)
- ⓬ REC button (13)
- ⓭ ■ (stop) button (7)
- ⓮ AUTO PAUSE button (11)
- ⓯ DISPLAY button (8)
- ⓰ AUTO/MANUAL button (14)
- ⓱ TITLE INPUT buttons (23)
- ⓲ TITLE SEARCH button (25)
- ⓳ ENTER button (18)
- ⓴ SET button (18)
- ⓵ CLEAR/DELETE button (11, 24)
- ⓶ ◀◀/▶▶ (skip) buttons (8)
- ⓷ ▶ (play) button (7)
- ⓸ || (pause) button (7)

Connecting the unit to the CRX-M5

Never plug the AC power cord into the wall outlet until all other connections are completed.

Follow the steps below to connect to the CRX-M5 using the supplied cords and accessories.

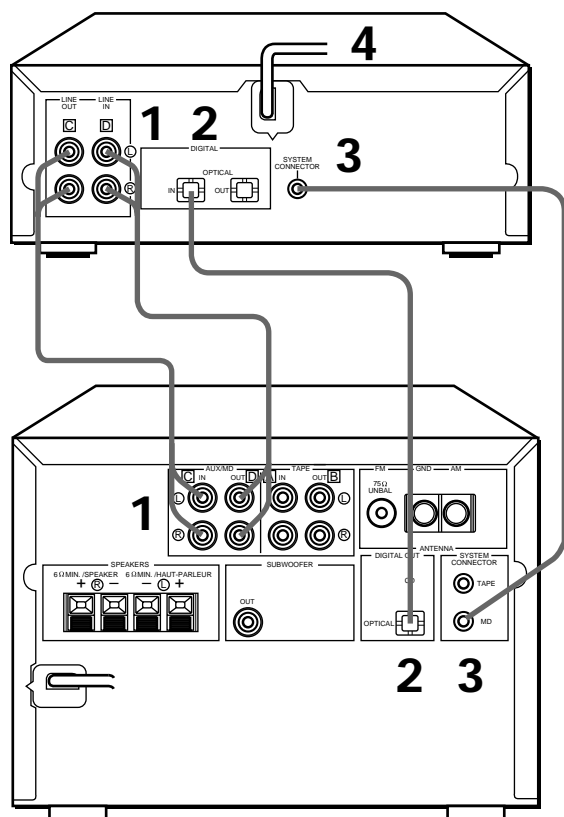

- 1** Connect **C** to **C**, and **D** to **D** using the audio connecting cords. Insert the plugs into jacks of the same color.
 - The two audio connecting cords are the same, so you can connect **C** or **D** using either cord.
 - The white plug of the audio connecting cord corresponds to the left channel and the red plug corresponds to the right channel. Make sure that the left and right channel connections are properly made, and that the plugs are inserted firmly.
- 2** Connect the OPTICAL DIGITAL IN jack of the unit and the DIGITAL OUT jack on the CRX-M5 with the optical fiber cable.
- 3** Connect the unit and the CRX-M5 with the system cable.
- 4** Connect the AC power cord to a wall outlet.

Digital connections

If you have another MD deck or DAT deck, you can make direct digital recording and enhance the sound quality for recording by connecting the OPTICAL OUT jack of the unit and the OPTICAL IN jack of another unit with the optical fiber cable.

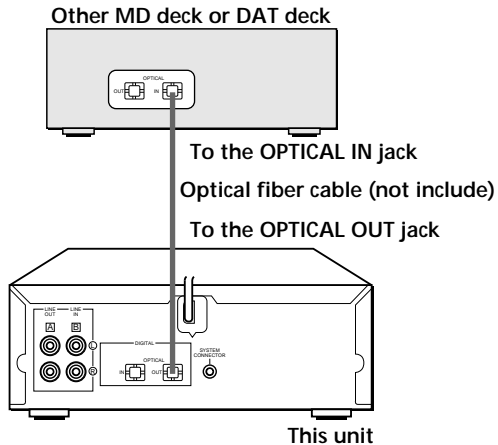

- Take off the covers of the optical fiber cable plug, the OPTICAL DIGITAL OUT jack, and the DIGITAL IN jack before digital connection.
 - * Use an optical fiber cable that conforms to EIAJ standards. Other cables might not function correctly.
- Be sure to replace the terminal's cover when the terminal on the rear panel is not being used, in order to protect from dust.

Turning on/off the unit

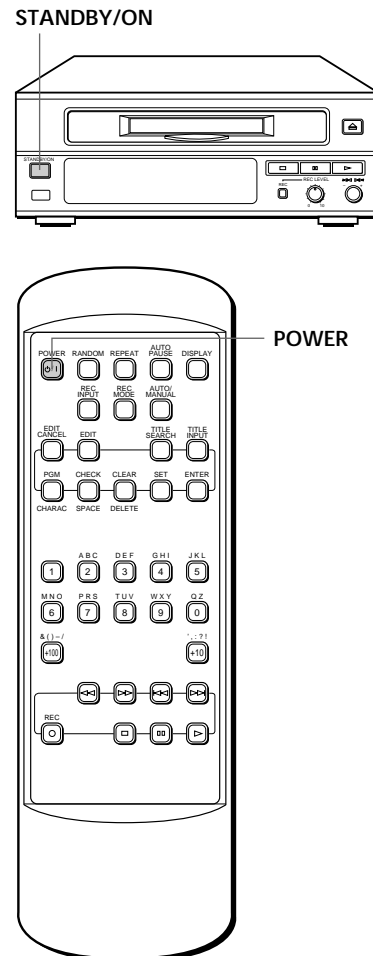

After connecting the AC power cord to the wall outlet, press the STANDBY/ON switch on the front panel or POWER on the remote to turn on/off the unit.

Preparing the remote control transmitter

Loading the batteries for the remote control transmitter

- 1 Remove the battery compartment cover.

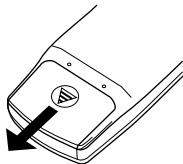

- 2 Insert 2 AAA size batteries into the battery compartment.

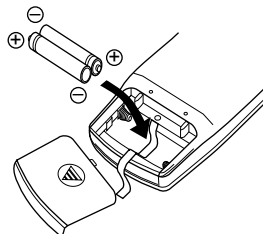

- 3 Replace the battery compartment cover.

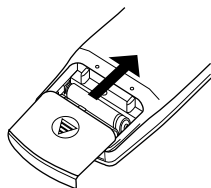

Battery replacement

If you find that the remote control transmitter must be used closer to the main unit than usual, the batteries are weak. Replace both batteries with new ones.

Notes

- Use only AAA batteries for replacement.
- Be sure the polarities are correct. (See the illustration inside the battery compartment.)
- Remove the batteries if the remote control transmitter will not be used for an extended period of time.
- If batteries leak, dispose of them immediately. Avoid touching the leaked material or letting it come in contact with clothing, etc. Clean the battery compartment thoroughly before installing new batteries.

Remote control transmitter operation range

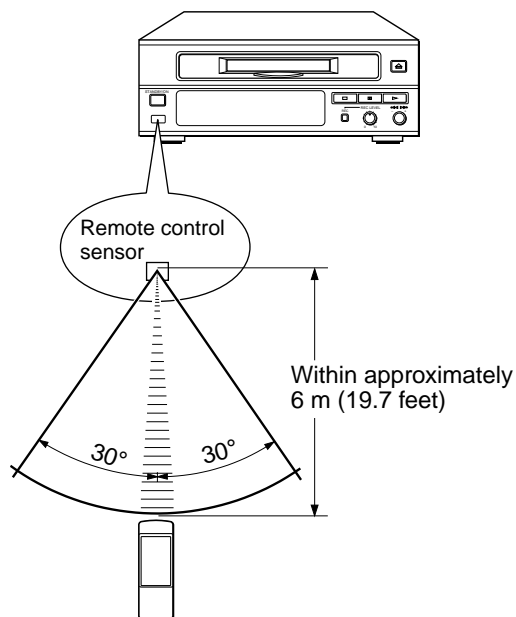

Notes

- There should be no large obstacles between the remote control transmitter and the main unit.
- If the remote control sensor is directly illuminated by strong lighting (especially an inverter type of fluorescent lamp etc.), it might cause the remote control transmitter not to work correctly. In this case, reposition the main unit to avoid direct lighting.

Note

- This manual describes how to operate this unit by using the remote control transmitter mainly. To operate the unit from the front panel, use the corresponding buttons on the front panel (see page 3).

MD playback

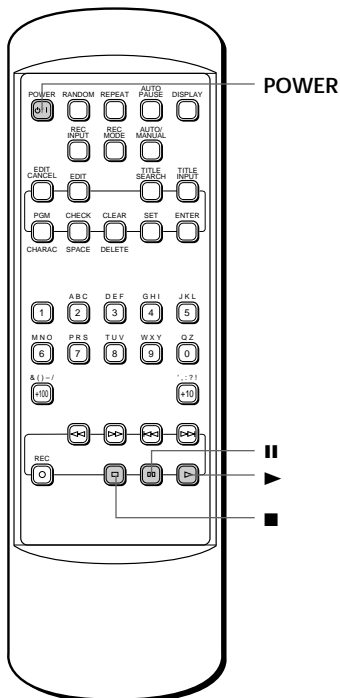
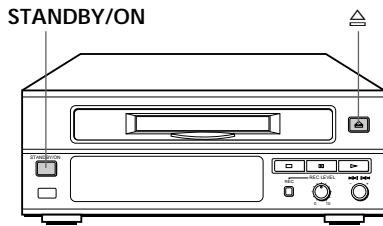

- 1 Press STANDBY/ON or POWER to turn on the unit.
 - When you turn on the CRX-M5, the unit turns on automatically as it is connected to the CRX-M5 with the system cable.
- 2 Insert an MD.
Insert the MD securely so that it clicks into place.

Arrow pointed toward the disc insertion slot

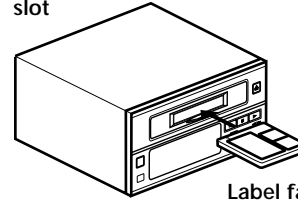

- 3 Press ► to start playback.
Playback starts from the beginning track of the MD.

To stop playback completely

Press ■.

To stop playback temporarily

Press II.

To resume playback, press II again or press ►.

To eject an MD

Press △.

To play a specific track on the disc

Direct play

Select a desired track by using the number buttons.
 (Example: To select 235, press +100 twice so that "2 -" appears in the display, and press + 10 three times so that "2 3 -" appears in the display, then press 5.)

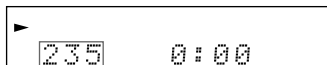

Selected track

The unit starts playback from the selected track automatically.

Skip play

- To skip to a succeeding track, press ►► once or repeatedly, or turn the jog dial clockwise until the desired track number appears.
- To skip to the beginning of the current track, press ◀◀ once, or turn the jog dial counterclockwise so that it clicks.
- To skip to a preceding track, press ◀◀ once or repeatedly, or turn the jog dial counterclockwise until the desired track number appears.

Notes

- You cannot enter a number that is higher than the last track number on the disc.
- These operations can also be performed when the unit is in the pause or stop mode.
- If ►► or ◀◀ is pressed and held, the track number successively changes to higher numbers (or lower numbers).

To advance or reverse play rapidly (Manual Search)

Press and hold ►► to advance playback rapidly, and ◀◀ to reverse playback rapidly.

The sound can be heard (although slightly garbled) during manual search in either direction. This is convenient for locating a precise position within a track, or for reviewing the contents quickly.

Note

- Manual search can also be performed during pause, though no sound will be heard.

Selecting the time display

When you insert an MD the disc title is displayed automatically. Pressing DISPLAY during playback or stop lets you display other information, such as the remaining time and track titles.

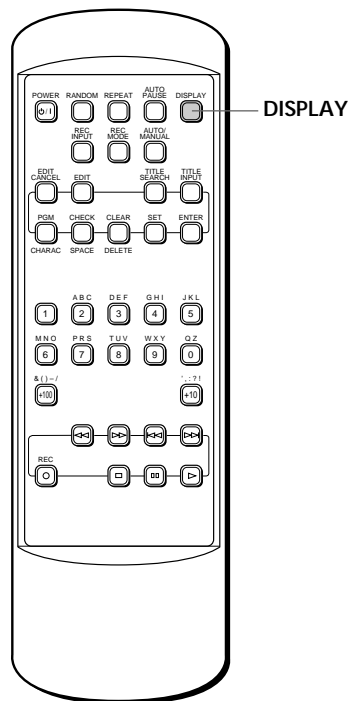

Each time you press DISPLAY, the display changes as follows:

Disc title (during stop) or track title (during playback)

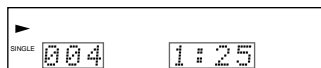
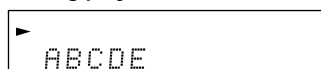

Track number Elapsed time

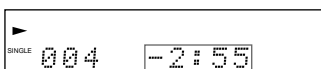

Remaining time



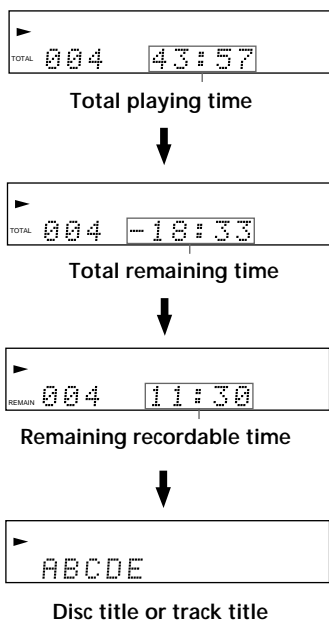

Random-sequence play

The unit can play all the tracks on an MD in a random sequence selected by the unit's microcomputer.

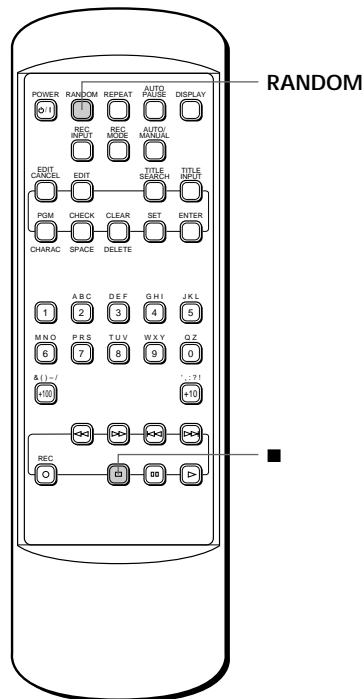

To start random-sequence play

Press RANDOM.

"RANDOM" appears in the display.

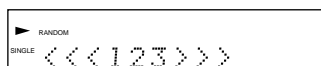

Playback starts automatically.

To cancel random-sequence play mode

Press ■.

"RANDOM" disappears from the display.

Notes

- This feature will not function during programming, or during programmed play.
- If ►► is pressed during random-sequence play, the next randomly programmed track will be played. If ◀◀ is pressed, play will return to the beginning of the current track.

Repeat play

You can play a disc repeatedly.

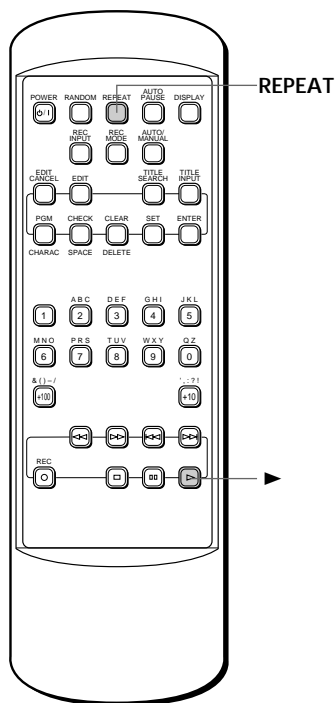

- 1 Press REPEAT.
"REPEAT" appears in the display.

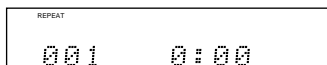

- 2 Press ► to start repeat play.

To cancel repeat play mode

Press REPEAT so that "REPEAT" disappears from the display.

Note

- You can enjoy repeat play during random-sequence play. In this case, the unit plays the disc repeatedly in the different order.

Program play

By creating a program, you can enjoy listening to your favorite tracks in any desired order. As many as 32 steps can be programmed in sequence.

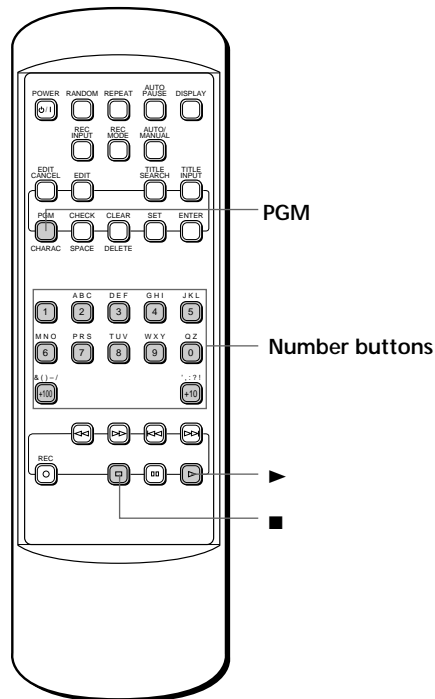

- 1 Press ■ to stop the unit.
- 2 Press PGM.
"PGM" appears in the display.



- 3 Select the desired track by using the number buttons.

- 4 Press PGM.
The selected track is programmed.

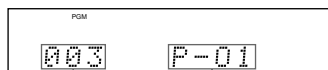

Selected track number Program number

- 5 Repeat steps 3 and 4 to program more tracks. You can select the same track again.
- 6 Press ► to start program play.

To stop program play mode

Press ■.

To cancel program play

Press PGM so that "PGM" disappears from the display.
The program you set is erased.

Notes

- You cannot program a track which is not included in a disc.
- or ◀◀ can be used during program play to skip to tracks within the program.

To check the program data

- Press ■ to stop program play.
- Press CHECK. Each time you press this button, the track number and the program number are displayed in the order of the program.

To change program data

- Follow the preceding procedure described in "To check the program data."
- Display the track number to be corrected by pressing CHECK.
- Press the number button of the track you want to substitute for the one currently displayed. The previously programmed track will be cleared from the memory and the new one will be programmed.
- Press PGM.

To delete tracks from the program

Press CLEAR during stop in program play mode.
The last programmed track is erased.

Auto pause function

The unit can automatically pause playback after playing the current track.

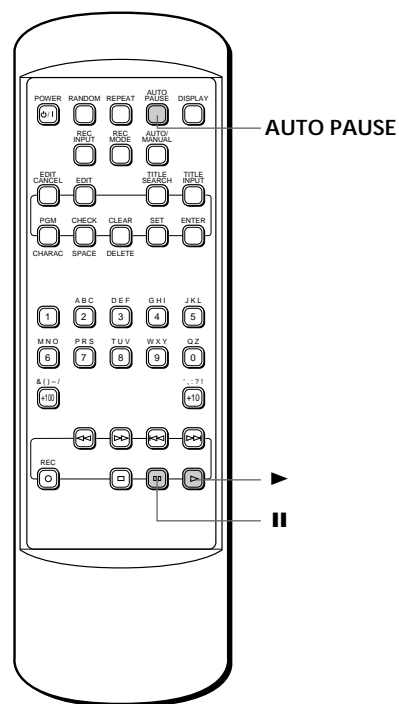

Press AUTO PAUSE so that "A. PAUSE" appears in the display.

The unit pauses playback after playing the current track.

To resume playback

Press ► or ►►.

To cancel auto pause function

Press AUTO PAUSE so that "A. PAUSE" disappears from the display, or press POWER to turn off the unit.

Before recording

MDs (Mini Disc) let you digitally record and play music with high quality sound. Another feature of MDs is track marking. The track marking feature lets you quickly locate a specific point or easily edit the recorded tracks. However, depending on the source you record from, the recording method and the way the track numbers are recorded differs.

Notes on digital recording

- When recording from a digital source (such as CD, DAT, etc.), the unit converts the digital signals to 44.1 kHz for recording onto the MD. The unit can record 32, 44.1, and 48 kHz digital signals.
- When recording from an analog source (such as cassette tape, tuner, etc.), the unit converts the analog signals to a 44.1 kHz digital signal.

When the source you record from is:

• CRX-M5's CD player

- You can record from CD to MD with the CD synchronized recording function (see page 14).
- The digital signal from the CD is recorded as it is.
- Track numbers are automatically marked as on the original CD.

• Other digital components

- Track numbers are automatically marked as it is when you turn on the Auto track marking function (see page 14).

• CRX-M5's tuner or other analog components

- The analog signal is converted to a digital signal and recorded.
- Track numbers are automatically marked when you turn on the Auto track marking function (see page 14) in sync with the level of the input signal.

Notes about TOC

- On an MD, the track number (track sequence), playback times, title data, etc., are recorded in the TOC area independent of the sound information. You can edit recorded tracks quickly by modifying the TOC information.
- Recording on an MD is completed when the TOC writing is finished. Normally, the TOC information is written automatically, but you can set it manually by setting REC END WRITING function to OFF (page 16). TOC writing starts when you do any of the following operations.
 - Eject the MD.
 - Press STANDBY/ON.
 - In this case, if you pull out the AC power cord before TOC writing is finished, the recorded contents will not be memorized on the MD.
- TOC writing may be impossible (or Auto track number marking may not perform as expected) when recording a damaged CD or a broadcast source under interference.

Recording on an MD

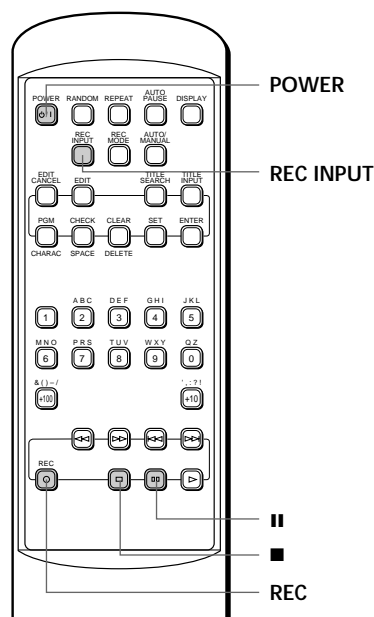

1 Turn on the recording source and set it for playback.

2 Insert an MD.

Arrow pointed toward the disc insertion slot

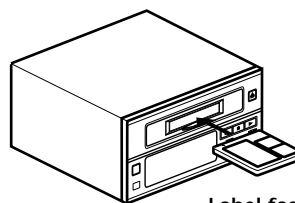

Label facing up

- 3** Press REC INPUT repeatedly to select the input connected to the sound source you want to record from.

The selected indicator appears in the display.

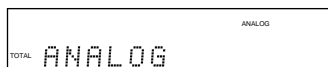

For normal recording from the LINE IN input
(Ex. Tuner, tape deck, etc.)

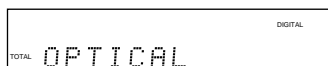

For digital recording from the DIGITAL IN input
(Ex. CD, DAT deck, etc.)



For long recording (monaural) from the LINE IN input (see page 15)

- 4** Press REC to set the unit to recording pause mode.
"REC" and "II" appear in the display.

- If you selected ANALOG or MONO in step 3, adjust the recording level as described in "Recording level" on this page.

- 5** Start playing the source to be recorded.

- 6** Press REC or II to start recording.

To stop recording

Press ■.

To pause recording

Press II.

Press II again or REC to resume recording.

Notes

- When recording from a digital source other than the CRX-M5 that has a digital output (volume) control, set the output level to "MAX." Recording may not be possible at low output levels (when the digital volume is turned down).
- Each time you press DISPLAY while recording, the display changes as follows:

Current track number and recording time of the current track



Current tracks and total playing time



Remaining recordable time

After recording

Press POWER or press STANDBY/ON to turn the unit off. The unit updates the TOC information of the MD and the recording is completed.

Recording level

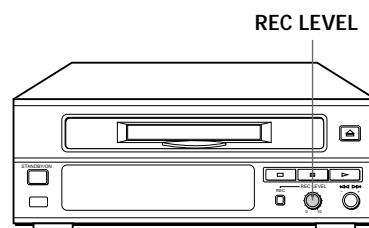

To set the recording level, first play the loudest passage of the source to be recorded. Then set the unit to the record pause mode (press REC) and watch the meter readings. Adjust the recording level by turning the REC LEVEL control so that the highest peak causes the 0 dB level indicators to flicker. The OVER indicators should not light.



OVER indicator

Note

- Although some sources can be recorded with lower peak levels, setting the peak levels too low may degrade the quality of the recording.

Auto track marking

When making a recording, you can choose either automatic or manual track marking. This feature operates somewhat differently for analog and digital signals. See below for details.

Press AUTO/MANUAL repeatedly to select automatic track marking ("MANUAL" disappears from the display) or manual track marking ("MANUAL" appears in the display).

When recording analog signals

Auto: Track numbers are written in synchronization with the input level of the signal being recorded. In other words, if the source signal falls below a certain level for more than 2 seconds, a track number is written automatically the next time the source signal rises above that level. You can change the level and time settings (see page 16).

Manual: One track number is written automatically when you start recording, but none are written during recording. To write track number manually, press EDIT at the desired point during recording.

When recording digital signals

Track numbers are written in the same positions as the original source (CD, etc.) with automatic track marking. When you set the unit to manual track marking, press EDIT at the desired point to write track number during recording.

Note

- When recording is paused, the portion recorded up to the pause is counted as an individual track. When recording is resumed, a new track number is created. On the other hand, if one track is recorded in continuous repetition, that track is recorded as one continuous track with a single track number.

CD synchronized recording

You can easily record a CD on a MD when you connect the unit to the CRX-M5.

This function is operated from the CRX-M5. For more details, see the instructions of the CRX-M5.

- 1 Insert the desired disc into the CRX-M5.
- 2 Insert an MD.
- 3 Press DISC 1 – 3 to select the desired CD, then press ■ after playing for several seconds.
- 4 Press CD SYNC when both units are in stop mode and press ◀◀/▶▶ repeatedly so that "CD → MD" appears in the display.
- 5 Press CD SYNC .
The CRX-M5 starts CD play from the beginning of a disc and the unit starts recording automatically.
- 6 Both units stop automatically when recording is finished.

To stop CD synchronized recording

Press ■ (CRX-M5) or ■ (MDX-M5).

When you press ■ (MDX-M5) and the REC END WRITING function set to ON, the CRX-M5 stops about 10 seconds after you press the button.

Notes

- You can record a CD on an MD with CD synchronized recording by using various way as follows:
 - recording from the desired track of a CD
 - recording programmed track
- When the MD becomes full in the middle of the recording, both units stop.
- Adjusting the VOLUME control of the CRX-M5 has no effect on the recorded sound.

Monaural recording

Recording in monaural allows you to record up to 148 minutes of sound on one 74 minute-MD (when recording in stereo you can record up to 74 minutes of sound). This may be useful when recording an interview, debate, or speech, etc., whenever you want to record a long time on one disc.

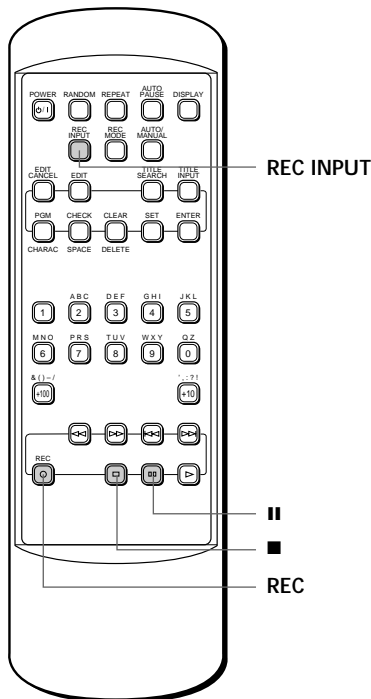

- 1 Follow the steps from 1 to 4 described in "Recording on an MD" on page 12.
- 2 Press REC INPUT repeatedly so that "MONO" appears in the display.



- 3 Adjust the recording level as described in "Recording level" on page 13.
- 4 Press REC to set the unit to recording pause mode.
"REC" and "II" appear in the display.
- 5 Start playing the program source to be recorded.
- 6 Press REC or II to start recording.

To stop recording

Press ■ (MDX-M5).

To pause recording

Press II.

Press II again or REC to resume recording.

Changing recording mode

In this mode, you can change the level and time settings to make the unit write track numbers automatically (Auto track marking function), and set the REC END WRITING function to ON/OFF.

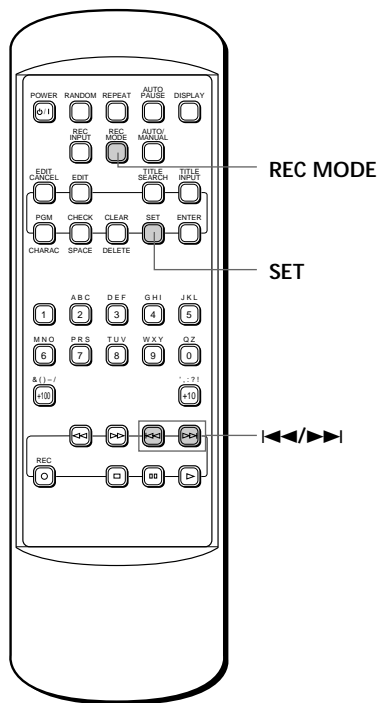

- Press ◀▶ to select the value you want to, then press SET. Each time you press ◀▶, the value changes as follows:

TIME: 0.5SEC → 1.0SEC → 1.5SEC → *2.0SEC
 ↓
 2.5SEC → 3.0SEC → 3.5SEC → 4.0SEC

LEVEL: -2 → -1 → *0 → 1 → 2

REC→WRITING?: *ON ↔ OFF

The value with * is a initial value.

- For more settings, repeat steps 2 to 4.
- Press REC MODE after complete the setting.

- Press REC MODE during stop or recording. "AUTO TIME ?" appears in the display.
- Press ◀▶ to select the mode you want to change. Each time you press ◀▶, the display changes as follows:

AUTO TIME ? (for changing the time)
 ↓
 AUTO LEVEL ? (for changing the level)
 ↓
 REC→WRITING? (setting the REC END WRITING function to ON/OFF)

- Press SET. Initial setting appears in the display.

AUTO TIME: TIME *2.0SEC
 AUTO LEVEL: LEVEL *0
 REC→WRITING: WRITING *ON

Before you start editing

One of the main advantages of the MD is its editing capabilities, you can remove the commercials from a radio broadcast, arrange the songs in the order you want, remove songs, combine songs, and name titles.

Edit functions

The unit offers the following editing operations. (Please note that track numbers are updated automatically when you perform MOVE, ERASE, COMBINE, or DIVIDE operations.)

- **MOVE**
Lets you move a track to a different track number.
- **ERASE**
Lets you erase a track or the entire disc.
- **COMBINE**
Lets you combine two tracks into a single track.
- **DIVIDE**
Lets you split a single track into two different tracks.
- **TITLING**
Lets you title recorded MDs and the individual tracks.

Notes on editing

Before editing

Make sure that the MD is not protected against erasure. If the MD is protected, you cannot edit the MD. Slide the tab to close the slot.

After editing

Press \triangle and pull the MD out, or press STANDBY/ON to turn off the unit in order to update the TOC information.

To undo the editing

The undo function lets you immediately return to the condition before the edit (note; you cannot undo an edit once you press any other buttons).

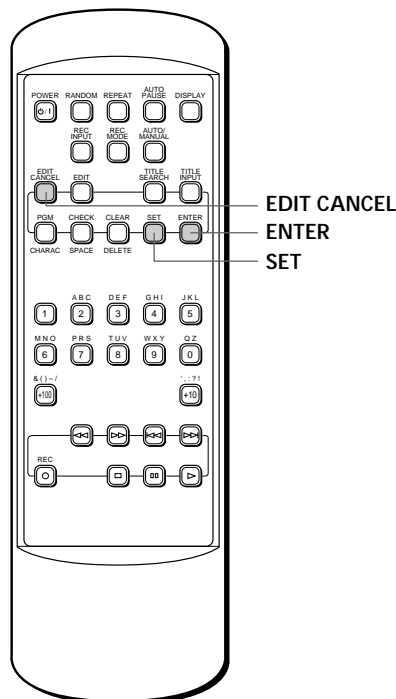

- 1 Press EDIT CANCEL during stop.

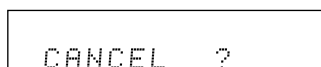

- 2 Within 8 seconds, press SET.

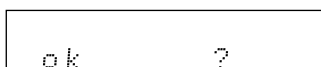

- 3 Press ENTER.
The previous edit is cancelled.

Erase

This function lets you erase unwanted tracks quickly and easily. When you erase a track, the total number of tracks on the MD decreases by one and all the tracks following the erased one are renumbered.

Caution for erasing

Check carefully the portion to be erased, as you cannot undo an edit once any additional edit has been performed.

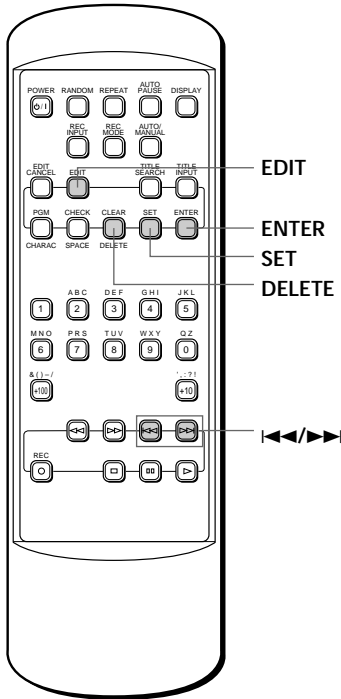

To erase the current track

You can erase the track now being played.

For example: Erasing track 3

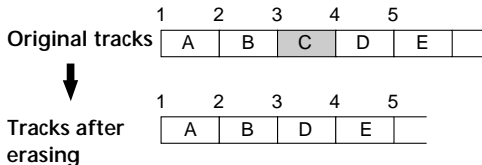

- 1 Press EDIT during playback of the track you want to erase.

- 2 Press **◀◀/▶▶** repeatedly so that “ERASE ?” appears in the display, then press SET or ENTER.



Track number to be erased

- 3 Press ENTER.



- 4 Press ENTER.

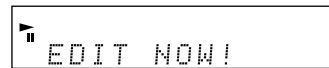

To erase more than one track at once

You can erase the several tracks at once.

For example: Erasing tracks 2 and 4

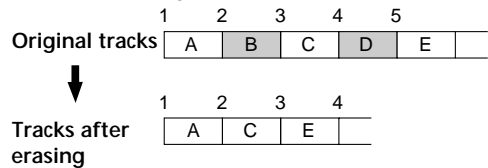

- 1 Press EDIT during stop.
- 2 Press **◀◀/▶▶** repeatedly so that “Q. ERASE ?” appears in the display, then press SET or ENTER.

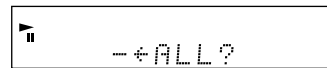

- 3
 - To erase all the tracks of the MD, press SET, and skip the following steps 4 and 5 (“ALL” appears in the display).
 - To select the tracks you want to erase, skip this step.
- 4 Press **◀◀/▶▶** repeatedly or turn the jog dial to select the track you want to erase, then press SET.



Track number you want to erase

5 Repeat step 4 for more settings if required.

- You can check the settings by pressing ◀◀/▶▶.
- You can undo the last track number you set by pressing DELETE.

6 Press ENTER.



7 Press ENTER.

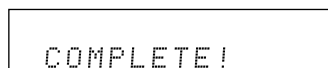
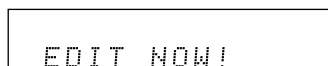

To cancel the Erase function

Press EDIT while editing.

Note

- When you cannot edit because of the limitations of the MD system, "CAN'T EDIT" appears in the display and the Erase function is canceled.

Move

This function lets you change the position of any track. When you move tracks, all the tracks are automatically renumbered.

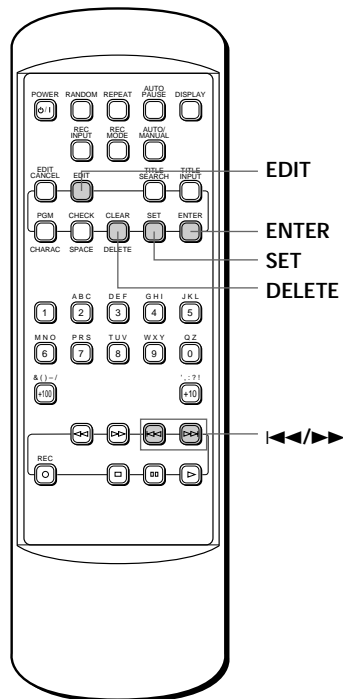

To move the current track

You can move the track now being played.

For example: Moving track 3

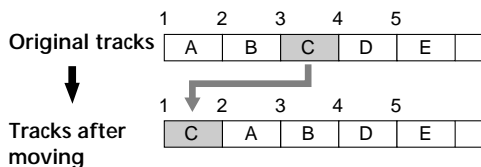

- 1 Press EDIT during playback of the track you want to move.
- 2 Press ◀◀/▶▶ repeatedly so that "MOVE ?" appears in the display, then press SET or ENTER.

Track number you want to move



EDITING

3 Press **◀◀/▶▶** repeatedly or turn the jog dial to select the new track number.

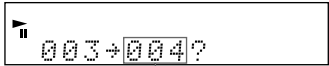

New track number

4 Press SET or ENTER.



5 Press ENTER.

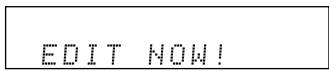

The unit pause at the beginning of the moved track.

To move more than one track at once

You can move several tracks at once.

For example: Moving tracks 1, 3, and 6

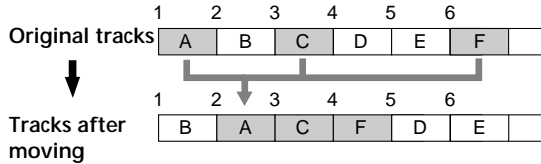

1 Press EDIT during stop.

2 Press **◀◀/▶▶** repeatedly so that "Q. MOVE ?" appears in the display, then press SET.

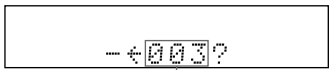

Track number you want to move

3 Press **◀◀/▶▶** repeatedly or turn the jog dial to select the first track you want to move, then press SET.

4 Repeat step 3 for more settings if required.

- You can check the settings by pressing **◀◀/▶▶**.
- You can undo the track number you set last by pressing DELETE.

5 Press ENTER.

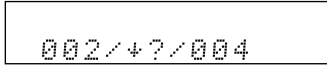

Ex. Selected tracks move to between track number 2 and 4

6 Press **◀◀/▶▶** repeatedly or turn the jog dial to select the track's destination, then press ENTER.

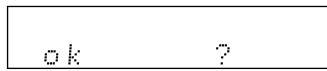

7 Press ENTER.

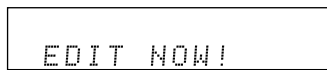

To cancel the Move function

Press EDIT while editing.

Note

- When you cannot edit because of the limitations of the MD system, "CAN'T EDIT" appears in the display and the Move function is canceled.

Combine

This function lets you combine two consecutive tracks into one. After you combine the tracks, the total number of tracks decreases by one and the tracks are automatically renumbered.

For example: Combining track 2 and 4

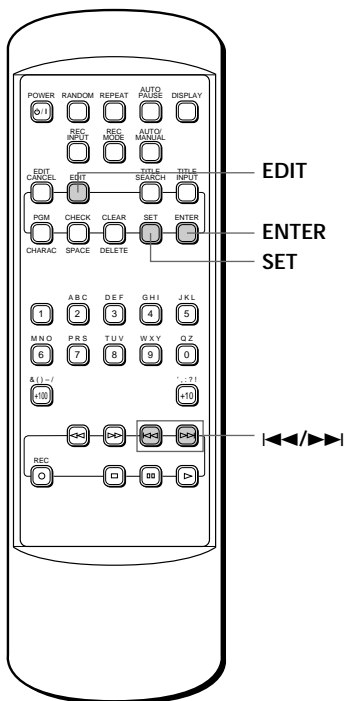
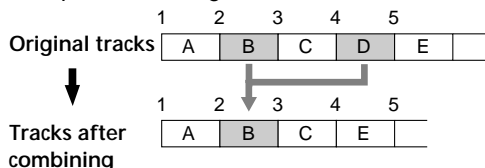

4 Press ENTER.



5 Press ENTER.

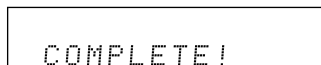

Note

- When you cannot edit because of the limitations of the MD system, "CAN'T EDIT" appears in the display and the Combine function is canceled.

- 1 Press EDIT during playback of the track you want to combine.
- 2 Press repeatedly so that "COMBINE ?" appears in the display, then press SET.

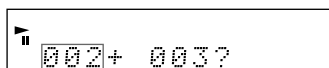

Track number being played

- 3 Press repeatedly or turn the jog dial to select the track to be combined, then press SET.

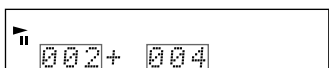

Track numbers you want to combine

Divide

This function lets you divide one track into two separate tracks by adding a new track number to a certain point in the track. If you add a track number at the beginning of a section you want to listen to, you can access it quickly by using the skip function. The total number of tracks increases by one and all the tracks following the new division are renumbered.

For example: Dividing track 3

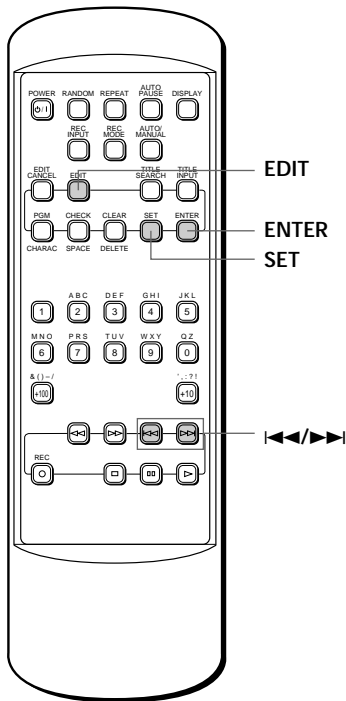
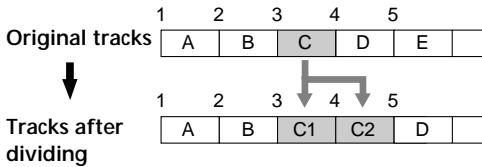

- 3 Press SET.
"DIVIDE+00" appears in the display.
- 4 Press SET.
The unit starts repeated playback in a three seconds cycle starting from the dividing point.
- 5 Press ◀◀/▶▶ repeatedly to adjust the dividing point.
You can adjust at 0.06 seconds interval up to 32 steps in the forward direction.
- 6 Press ENTER to decide the dividing point.

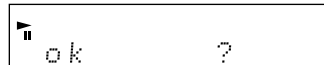

- 7 Press ENTER.

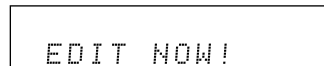

To cancel the Divide function
Press EDIT while editing.

Note

- When you cannot edit because of the limitations of the MD system, "CAN'T EDIT" appears in the display and the Divide function is canceled.
- There is no blank space left between two tracks you divide.

- 1 During playback, press EDIT at the point you want to divide.
"DIVIDE?" flashes in the display.
- 2 During "DIVIDE?" flashing in the display, press SET.
When you do not adjust finely the dividing point, go to step 6.

Titling

This function lets you title recorded MDs and individual tracks. Titles may consist of capital and small letters, numbers, and symbols for a maximum of 80 characters for each title.

When titling, you can use the preset names memorized in the unit to title quickly. You can also edit the preset names.

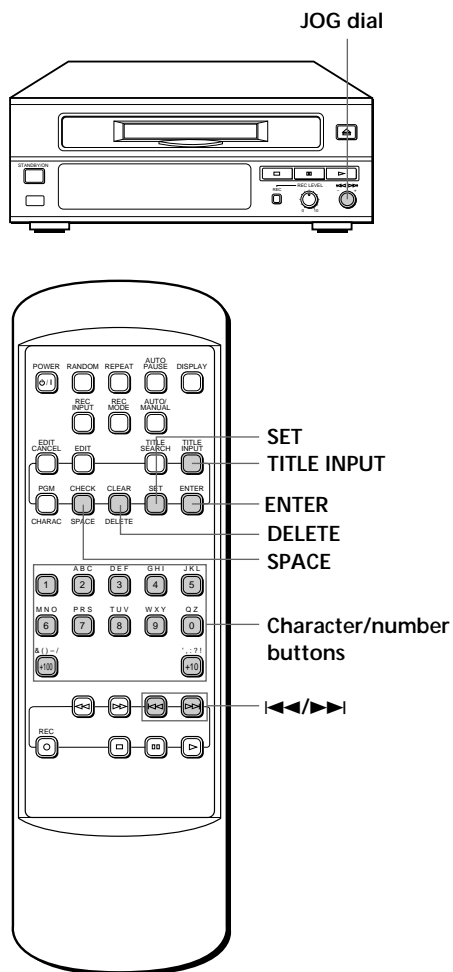

- 1 Press TITLE INPUT. When you press TITLE INPUT during playback, skip to step 3 and you can title the track being played directly.

- 2 During "TITLE" flashing in the display, press ◀▶ repeatedly to select the title, track number, or preset pattern. Each time you press ◀▶, the display changes as follows:

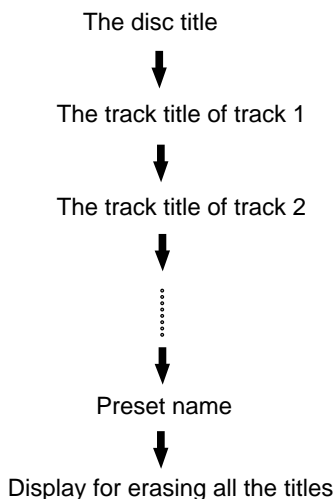

- **When you select the disc title or track title**
Edit the disc or track title by following the procedure described below.
- **When you select the preset name**
Edit the preset name by following the procedure described below.
- **When you select "ALL ERASE" to erase all the titles**
Press SET or ENTER. All the titles on the MD are erased.

- 3 Press SET.

When there is no data

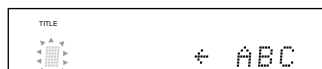

When there is data

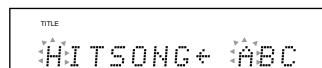

4 Press CHARAC to select the type of character. Each time you press CHARAC, the type of character changes as follows:

- Capital letters (space, A, B, C, ... Y, Z)
- ↓
- Small letters (space, a, b, c, ... y, z)
- ↓
- Figures, symbols, and preset numbers (0, 1, 2, ... PRE8, PRE9)

5 Press ◀▶ to move the cursor position, and press ◀◀▶▶ repeatedly to select the desired character, then press SET.

- **To input a space**
Press SPACE.
- **To delete a character**
Move the cursor position to the character you want to delete, then press DELETE.
- **When you select the preset number**
The title of the preset number is input at the selected cursor position.
The initial preset titles are:

- PRE1 Pops
- PRE2 Rock
- PRE3 Classic
- PRE4 Jazz
- PRE5 Disco
- PRE6 Best Hits
- PRE7 Air Check
- PRE8 NO.
- PRE9 Vol.

- 6** Repeat steps 4 and 5 to complete the title.
- 7** Press ENTER.
The unit saves the title you input, and displays it.
- 8** Press TITLE INPUT to exit title input mode.

CAUTION

- If you press TITLE INPUT after you input the title but before pressing ENTER, the title you input is erased.

To input characters using the character buttons
You can input characters using the character buttons on the remote control transmitter instead of ◀◀▶▶ in step 5 above.

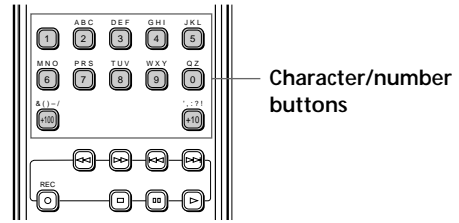

Press the desired character button. Each time you press the button, the character to be input changes.

Example: When you select Capital letters,
To select "A," press ABC once.
To select "B," press ABC twice.
To select "C," press ABC three times.

Note

- A maximum of 1792 characters can be input on each disc.

To correct a title

1. Follow the steps 1 to 4 described in "Titring" on page 23.
2. Move the cursor position to the character you want to correct by pressing ◀▶.
3. Select the desired character by pressing ◀◀▶▶.
4. Press TITLE SEARCH to select the overwrite mode or the insert mode.
Each time you press TITLE SEARCH, the mode changes as follows:

Overwrite mode:

Inputs a character by replacing the current character.



Insert mode:

Inputs a character before the current character.

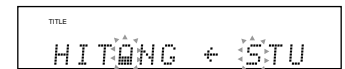

5. Press SET.
6. Repeat steps 2 to 5 until all the correction are completed.
7. Press ENTER, then press TITLE INPUT.

Title search

You can easily locate a desired track using the title you input.

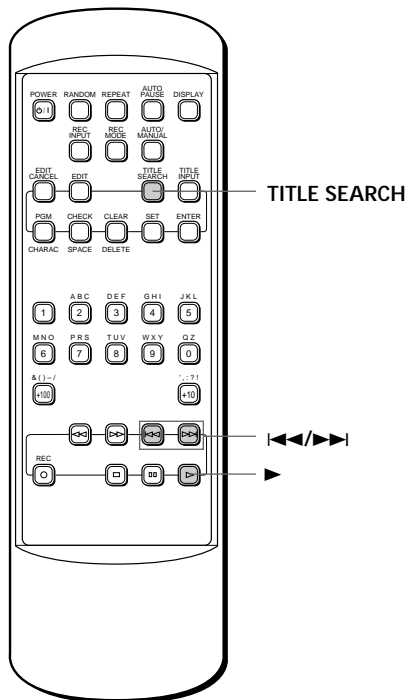

Timer operation

If you connect the unit and the CRX-M5 with the system cable, you can enjoy various timer play modes. For details, refer to the instructions of the CRX-M5.

To play an MD at a preset time

Insert the desired disc into the unit and set the CRX-M5 to timer play mode.

To stop an MD at a preset time

Play the desired disc with the unit and set the CRX-M5 to sleep timer mode.

To record a radio program on an MD at a preset time

Insert a blank disc into the unit and set the CRX-M5 to timer recording mode.

1 Press TITLE SEARCH during stop or playback.

- **During playback**

The title of the current track appears.

- **During stop**

The title of the first track appears.

2 Press <<||>> to select the desired title.

3 Press ▶ to start play.

The unit starts play from the beginning of the selected track.

Note

- When you press TITLE INPUT during title search, the unit enters title input mode automatically.

MD system limitations

The recording system in your MD recorder is radically different from those used in cassette and DAT decks and is characterized by the limitations described below. Note, however, that these limitations are inherent to the MD recording system and are not a result of mechanical trouble.

“DISC FULL” appears in the display before the maximum recording time (60 or 74 minutes) has been reached

Once 255 tracks have been recorded on one MD, “DISC FULL” appears in the display regardless of the total recorded time. More than 255 tracks cannot be recorded on one MD. To continue recording, erase unnecessary tracks, combine tracks to reduce the total number of tracks, or use another recordable MD.

“DISC FULL” appears in the display before the maximum number of tracks (255) have been recorded

During Automatic track marking, fluctuations in emphasis within songs may be interpreted as song intervals, increasing the song count and causing “DISC FULL” to be displayed.

The remaining recording time does not increase even after erasing numerous short tracks

Tracks under 12 seconds in length are not counted, so erasing them may not lead to an increase in the recording time.

“READING” appears in the display continuously
“READING” lasts longer than normal when a brand new (blank) disc is inserted.

The total recorded time and the remaining time on the MD does not equal the maximum recording time

- Recording is done in minimum units of 2 seconds each, no matter how short the material. The contents recorded may thus be shorter than the maximum recording capacity. Disc space may also be further reduced by scratches.
- The unit displays the length of the largest continuous blank area as the remaining time. If there are several separate blank spaces, the remaining time will only display a time equivalent to the largest continuous blank space.
For example, if there is a 1 minute blank space and a 2 minute blank space, the remaining time display will be “2” minutes. If you then record 1 minute and 30 seconds of the 2 minutes blank, the remaining time display will become “1” minute.

Tracks created by editing may exhibit sound dropout during search operations.

Track numbers are not recorded correctly

Incorrect assignment or recording of track numbers may result when CD tracks are divided into several smaller tracks during digital recording.

Limitations when recording over an existing track

- The correct remaining recording time may not be displayed.
- You may find it impossible to record over a track if that track has been recorded over several times already. In this case, erase the track using the Erase function.
- The remaining recording time may be shortened out of proportion to the total recorded time.
- Recording over a track to eliminate noise is not recommended since this may shorten the duration of the track.
- You may find it impossible to label a track while recording over it.

The correct recorded/playing time may not be displayed during playback of monaural-format MDs.

About copy protection

As a digital audio component, the unit conforms with the Serial Copy Manager System (SCMS) standards. The Serial Copy Manager System restricts copies made by recording digital signals to first-generation copies only. Therefore, an MD recorded through a digital input cannot be used as a source for making another digital recording.

However, subsequent recordings can be made from the first-generation copy by using the analog input/output jacks.

There are three general rules that apply to the unit.

Rule 1

You can record from digital program sources (CDs, DATs, or pre-mastered MDs) onto a DAT tape or recordable MD via the digital input jack on a DAT or MD recorder. You cannot, however, record from the recorded DAT tape or MD to another DAT tape or recordable MD via a digital input jack.

Rule 2

You can record a digital signal input from a digital satellite broadcast onto a DAT tape or recordable MD via the digital input jack on the DAT or MD recorder. (The unit is equipped with a sampling rate converter that allows you to make digital recordings from 32 kHz, 44.1 kHz, or 48 kHz digital program sources.) If the broadcast does not contain a copyright protection code, you can then record the contents of this recorded DAT tape or MD (first-generation) onto another DAT tape or recordable MD via a digital input jack on the DAT or MD recorder to create a second generation digital copy (these copies may also be copied digitally). Note, however, that if the broadcast contains a copy protection code, second-generation digital copying will not be possible.

Rule 3

You can record a DAT tape or MD recorded via the DAT or MD recorder's analog input jack onto another DAT tape or MD via the DAT or MD recorder's digital output jack. You cannot, however, make a second-generation DAT tape or MD copy via the DAT or MD recorder's digital output jack.

Notes about handling MDs

Protecting a recorded MD

- To protect a recorded MD, slide the tab on the side of the MD to open the slot.

In this position, the MD cannot be used for recording.

To record on the MD, slide the tab to close the slot.

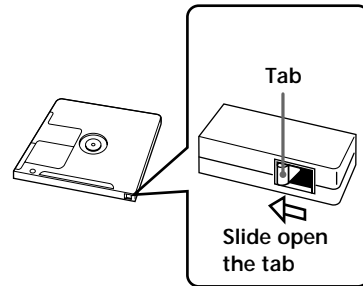

- If the MD is protected against erasure, "PROTECTED" appears in the display and the MD cannot be used for recording. Slide the tab to close the slot.

Care of MDs

- Do not expose the MD to direct sunlight or heat sources such as hot air ducts, nor leave it in a car parked in direct sunlight as there can be a considerable rise in temperature inside the car.
- Periodically remove dust and debris from the cartridge surface by wiping it with a dry cloth.
- Because the MD itself is housed in a cartridge, you can handle it normally without being concerned about dirt or fingerprints. However, malfunctioning may result if the cartridge itself is dirty or warped.
- Do not open the shutter to expose the MD. Close the shutter immediately if the shutter opens.

Troubleshooting

If the unit fails to operate normally, check the following points to determine whether the fault can be corrected by the simple measures suggested. If it cannot be corrected, or if the fault is not listed in the SYMPTOM column, disconnect the power cord and contact your authorized YAMAHA dealer or service center for help. When you repair the unit, the CRX-M5 may be needed. For details, contact and make sure your authorized YAMAHA dealer or service center.

SYMPTOM	CAUSE	REMEDY
The unit does not respond to operations.	MD is dirty or damaged.	Replace the current disc with a new one.
	MD is damaged ("DISC ERROR" appears in the display).	
The unit does not work normally.	There is an influence of strong external noise (lightning, excessive static electricity, etc.) or a misoperation was performed while using the unit.	Turn the unit off and disconnect the AC power from the wall outlet. After about 30 seconds have passed, connect the power and try again.
Playback is not possible.	Moisture on the laser pickup.	Leave the unit switched ON and wait 20 to 30 minutes for the moisture to evaporate before trying to play the disc.
	The power is OFF.	Press STANDBY/ON or POWER to turn the unit on.
	The disc has been loaded incorrectly.	Reload the disc with the label side facing up, and the arrow pointing toward the disc insertion slot.
	An unrecorded (blank) MD was loaded ("BLANK DISC" appears in the display).	Insert a recorded MD.
Recording is not possible.	The disc is protected from recording ("PROTECTED" appears in the display).	Slide the record-protect tab to the closed position.
	A pre-mastered MD is loaded ("PLAY ONLY" appears in the display).	Load a recordable MD.
	The source is not connected correctly.	Check all connections again.
	The input setting is incorrect.	Press REC INPUT repeatedly to select the correct input source.
	The recording level is too low.	Turn REC LEVEL to adjust the recording level.
	The digital output level of the digital source is too low.	Set the digital output level of the digital source to "MAX."
	There is not enough blank space left on the MD.	Load a recordable MD with fewer recorded tracks, or erase unnecessary tracks from the current MD.
	If the AC power cord was unplugged or there was a power outage during recording, that recording may be lost.	If recording was interrupted, try recording again starting from the beginning.
The MD cannot be removed when partially inserted.	The carriage lock function has been activated.	Insert the MD completely, then press \triangle to eject it.
Excessive noise.	The unit is too close to a television or other component.	Place the unit further away from the television or other component.
The remote control transmitter does not work.	The batteries of the remote control transmitter are too weak.	Replace the batteries with new ones.
	The remote control is too far away or is being used at incorrect angle.	Use within 6 m and 60° radius.
	Direct sunlight or lighting (of an inverter type of fluorescent lamp etc.) is striking the remote control sensor of the main unit.	Change the position of the main unit.
TV functions strangely when the remote control used.	The remote control is being used near TV set with a remote control sensor.	Relocate this unit away from the TV or cover TV's remote control sensor.

Display messages

When using the unit, the following messages may appear in the display. The meaning of the displayed messages are:

DISPLAYED MESSAGE	MEANING	REMEDY
NO DISC	There is no disc in the unit. Insert a disc.	Insert a disc.
UNLOCK	No digital signal being input to the selected digital input jack.	Make sure the connection for digital recordings are correct.
SCMS ON	An attempt is made to record digital signal from a source while its digital copy has been prohibited by SCMS.	Use analog recording.
Not Audio	The inserted disc is not an audio MD.	Insert an audio MD.
DISC FULL	Recording is not possible because there is no blank space remaining on the disc.	Change the disc with enough blank for recording.
TITLE FULL	Additional characters cannot be input for the current title because the maximum number of characters for a single title (80) have already been input.	Erase some characters.
BLANK DISC	The disc does not contain any recordings.	Change the recorded disc.
NO TRACKS	The disc does not contain any tracks but has a disc title.	Record some on the disc.
READING	The unit is reading the TOC data.	This is normal operation.
WRITING	The unit is writing the TOC data.	This is normal operation.
DISC ERROR	Problem involving TOC data.	Erase all tracks. If not possible, use another MD.
EDIT NOW!	The editing operation is in progress.	This is normal operation.
CAN'T EDIT	Edit operations are not possible because of MD system limitations.	Perform editing following the restrictions.
ok? (blinking)	This is message for confirming if editing can really be performed.	Press ENTER to perform editing.
PROTECTED	The record protection on the inserted MD is set to "protect".	See "Notes about handling MDs" on page 27.
PLAY ONLY	The inserted MD is a designed for playback only (you cannot record on this disc).	Insert the recordable MD.

Specifications

As a part of policy of continuous improvement, YAMAHA reserves the right to make design and specification changes for product improvement without prior notice. The performance specification figures indicated are nominal values of production.

Digital audio system

System	MiniDisc digital audio system
Frequency response (20 Hz to 20 kHz)	±1 dB
Sampling frequency	44.1 kHz
(32 kHz and 48 kHz signals are converted to 44.1kHz for recording)	

Laser Diode Properties

- Material: GaAs + GaAlAs
 - Wavelength: 785 ± 20 nm
 - Emission Duration: continuous
 - Laser Output: max. 50 μW*
- * This output is the value measured at a distance of about 200 mm from the objective lens surface on the Optical Pick-up Block.

General

Power supply	
[U.S.A. and Canada models]	AC 120 V, 60 Hz
[Australia model]	AC 240 V, 50 Hz
[U.K., Europe, and Singapore models]	AC 230 V, 50 Hz
[General model]	AC 115/230 V, 50/60 Hz
Power consumption	14 W
Dimensions	200 x 75 x 317 mm
Weight	2.8 kg

Klassmärkning för Finland

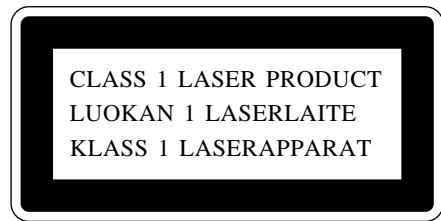

• **CAUTION**

Use the minidisc recorder only in accordance with the instructions given in this manual and do not attempt to interfere with the interlock switch or make any other adjustments as this may result in exposure to hazardous radiation.

• **VORSICHT**

Verwenden Sie den Mini-Disc Recorder nur entsprechend den in dieser Anleitung angegebenen Anweisungen, und versuchen Sie nicht, den Verriegelungsschalter zu beeinträchtigen, oder machen Sie keine andere Einstellung, da dies dazu führen kann, gefährlicher Ausstrahlung ausgesetzt zu werden.

• **ATTENTION**

Utiliser le lecteur-enregistreur minidisc en respectant les indications données dans ce manuel et éviter l'intervention sur le commutateur de verrouillage ou tout autre réglage. En cas de non-respect, on s'exposera à une radiation dangereuse.

• **PRECAUCIÓN**

Utilice el grabador/reproductor minidisc sólo de acuerdo con las instrucciones dadas en este manual y no intente interferir el interruptor de bloqueo ni realizar ningún otro ajuste porque podría ocasionar la exposición a radiación peligrosa.

• **OBSERVERA**

Använd den miniskivinspelaren endast i enlighet med anvisningarna i denna bruksanvisning och försök inte påverka läsningsströmbrytaren eller göra andra inställningar som kan leda till risk för farlig strålning.

• **ATTENZIONE**

Quando si usa il registratore de minidisc, seguire le istruzioni di questo. Non cercare di interferire con l'interruttore interbloccato e non effettuare altre regolazioni, poiché ciò potrebbe provocare un'esposizione a pericolose radiazioni.

• **LET OP**

Gebruik deze MiniDisc-recorder alleen zoals in de aanwijzingen in deze gebruiksaanwijzing staat vermeld. Maak geen veranderingen in de interlockschakelaar of andere onderdelen, daar dit mogelijk blootstelling aan gevaarlijke stralingen veroorzaakt.

VÝSTRAHA: VÝROBEK JE VYBAVEN LASEREM. PŘI NESPRÁVNÉ MANIPULACI S PŘÍSTROJEM V ROZPORU S TÍMTO NÁVODEM MŮŽE DOJÍT K NEBEZPEČNÉMU OZÁŘENÍ. NEOTVÍREJTE A NESNÍMEJTE PROTO ŽÁDNÉ KRYTY A PŘÍSTROJ NEOPRAVUJTE. OPRAVU A SERVIS SVĚŘTE ODBORNÉMU SERVISU.

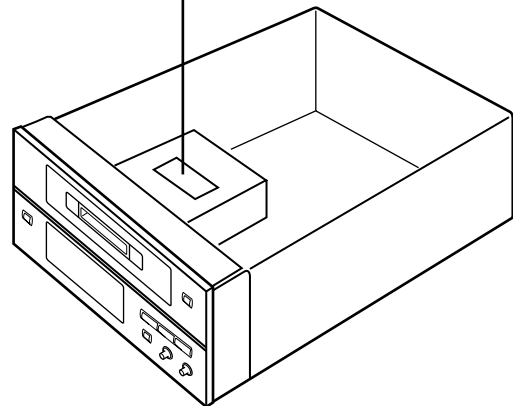

VAROITUS! LAITTEEN KÄYTTÄMINEN MUULLA KUIN TÄSSÄ KÄYTTÖOHJEESSA MAINITULLA TAVALLA SAATTA A ALTISTAA KÄYTTÄJÄN TURVALLISUUSLUOKAN 1 YLITTÄVÄLLE NÄKYMÄTTÖMÄLLE LASERSÄTEILYLLE.

VARNING - OM APPARATEN ANVÄNDS PÅ ANNAT SÄTT ÄN I DENNA BRUKSANVISNING SPECIFICERAS. KAN ANVÄNDAREN UTSÄTTAS FÖR OSYNLIG LASERSTRÅLNING, SOM ÖVERSKRIDER GRÄNSEN FÖR LASERKLASS 1.